

# IPV High-pressure internal gear pumps Technical data sheet

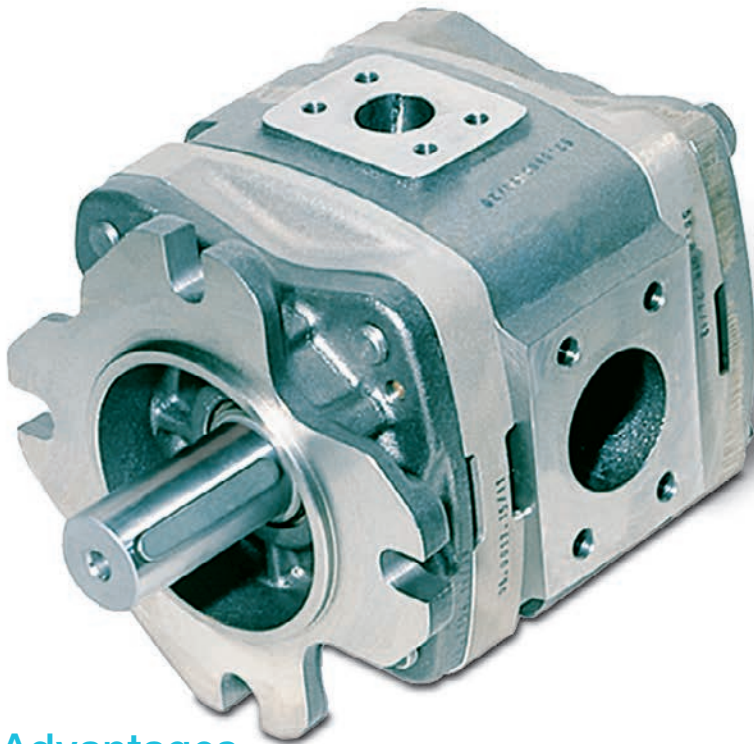

## Advantages

- + High volumetric and overall efficiency
- + Very good pulsation behavior
- + Robust and compact
- + Low noise emission
- + Multiple flow capable

## Design and function

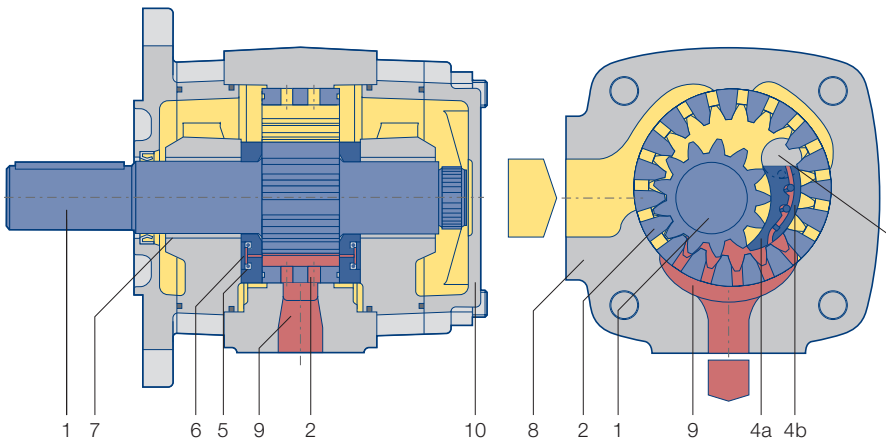

- 1 Pinion shaft
- 2 Internal gear
- 3 Filler pin
- 4a Filler segment carrier
- 4b Filler sealing segment
- 5 Axial disc
- 6 Axial pressure area
- 7 Plain bearings
- 8 Housing
- 9 Hydrostatic bearing
- 10 End cover with bleeder screw
- Suction chamber
- Pressure chamber

### Function

By rotation of the gears inside the pump, the pressure fluid (usually hydraulic oil) is drawn into the cavity between the pinion and internal gear. Optimized cross-sectional areas on suction side as well as on pressure side allow operation over a wide range of speed.

In the radial direction, the gear chambers are closed by gear meshing and the filler piece. In the axial direction, the axial plates seal the pressure chamber with the minimal possible gap. This design minimizes volume losses and increases efficiency.

### Calculations

Pump flow  $Q = V_{g\text{th}} \cdot n \cdot \eta_v \cdot 10^{-3} \text{ [l/min]}$

Power  $P = \frac{Q \cdot \Delta p}{600 \cdot \eta_g} \text{ [kW]}$

$V_{g\text{th}}$  pump volume per revolution [cm<sup>3</sup>]

$n$  Speed [rpm]

$\eta_v$  Volumetric efficiency

$\eta_g$  Overall efficiency

$\Delta p$  Differential pressure [bar]

### Technical data

<b>Design</b>	Internal gear pump with radial and axial sealing gap compensation
<b>Type</b>	IPV
<b>Mounting types</b>	SAE hole flange; ISO 3019/1 or VDMA hole flange; ISO 3019/2
<b>Line mounting</b>	SAE suction and pressure flange J 518 C Code 61
<b>Sense of rotation</b>	right or left-hand rotation
<b>Mounting position</b>	any
<b>Shaft load</b>	for details of radial and axial drive shaft loads please contact J.M. Voith SE & Co. KG
<b>Input pressure</b>	0.8...3 bar absolute pressure (at start up for short time 0.6 bar)
<b>Preload pressure. pressure port (in reversing mode)</b>	for details please contact J.M. Voith SE & Co. KG
<b>Pressure fluid</b>	HLP mineral oils DIN 51524. part 2 or 3
<b>Viscosity range</b>	10 ... 300 mm <sup>2</sup> s <sup>-1</sup> (cSt)
<b>Permissible start viscosity</b>	max. 2 000 mm <sup>2</sup> s <sup>-1</sup> (cSt)
<b>Permissible temperature of the pressure fluid</b>	-20 ... +80 °C
<b>Required purity of the pressure fluid</b>	Class 19/17/14 (ISO 4406). Class 8 (NAS 1638)
<b>Filtration</b>	filtration quotient min. $\beta_{20} \geq 75$ . recommended $\beta_{10} \geq 100$ (longer life)
<b>Permissible ambient temperature</b>	-20 ... +60 °C

## Characteristics

Type, size – delivery	Displacement per revolution [cm <sup>3</sup> ]	Speed min. [rpm]	Speed max. [rpm]	Delivery at 1 500 rpm [l/min]	Con- tinuous pressure [bar]	Peak pressure at 1 500 rpm [bar]	Peak pressure at n <sub>max</sub>	Moment of inertia [kg cm <sup>2</sup> ]
IPV 3 – 3.5	3.6	400	3 600	5.4	330	345	345	0.34
IPV 3 – 5	5.2	400	3 600	7.8	330	345	345	0.42
IPV 3 – 6.3	6.4	400	3 600	9.6	330	345	345	0.49
IPV 3 – 8	8.2	400	3 600	12.3	330	345	345	0.58
IPV 3 – 10	10.2	400	3 600	15.3	330	345	345	0.70
IPV 4 – 13	13.3	400	3 600	19.9	330	345	345	2.25
IPV 4 – 16	15.8	400	3 600	23.7	330	345	345	2.64
IPV 4 – 20	20.7	400	3 400	31.0	330	345	345	3.29
IPV 4 – 25	25.4	400	3 200	38.1	300	330	330	3.70
IPV 4 – 32	32.6	400	2 800	48.9	250	280	280	4.44
IPV 5 – 32	33.1	400	3 000	49.6	315	345	315	8.62
IPV 5 – 40	41.0	400	2 800	61.5	315	345	315	10.20
IPV 5 – 50	50.3	400	2 500	75.4	280	315	280	11.60
IPV 5 – 64	64.9	400	2 200	97.3	230	250	250	14.40
IPV 6 – 64	64.1	400	2 600	96.1	300	330	300	25.73
IPV 6 – 80	80.7	400	2 400	121.0	280	315	280	30.90
IPV 6 – 100	101.3	400	2 100	151.9	250	300	270	36.10
IPV 6 – 125	126.2	400	1 800	189.3	210	250	250	43.70
IPV 7 – 125	125.8	400	2 200	188.7	300	330	300	84.05
IPV 7 – 160	160.8	400	2 000	241.2	280	315	280	102.60
IPV 7 – 200	202.7	400	1 800	304.0	250	300	270	119.00
IPV 7 – 250	251.7	400	1 800	377.5	210	250	250	144.50

### The values given apply for

- Pumping of mineral oils with a viscosity of 20 ... 40 mm<sup>2</sup>s<sup>-1</sup>
- An input pressure of 0.8...3.0 bar absolute

### Notes

- Peak pressures apply for 15 % of operating time with a maximum cycle time of 1 minute
- Please inquire about peak pressures at non-standard speeds
- Due to production tolerances, the pump volume may be reduced by up to 1.5 %.

**IPV Size 3, Rotation and dimensions (mounting flange 0, shaft end 1)**

Rotation clockwise (cw)

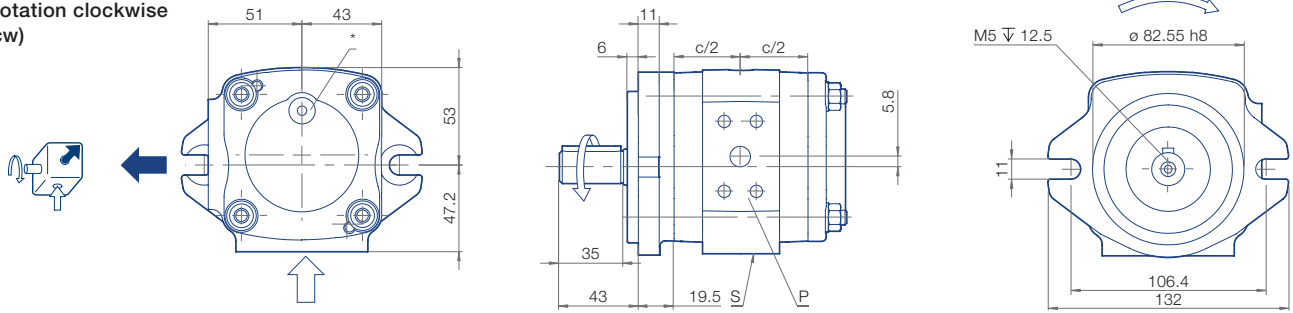

Rotation counter-clockwise (ccw)

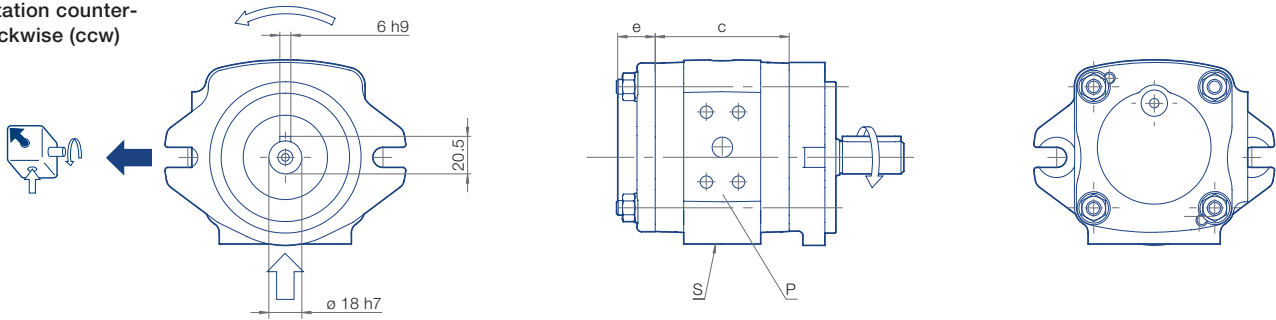

Pressure port (P)

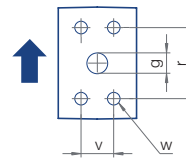

Suction port (S)

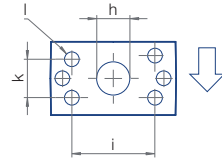

Type/ Delivery	c [mm]	e [mm]	g [mm]	h [mm]	i [mm]	k [mm]	l Thread	r [mm]	v [mm]	w Thread	Weight [kg]	SAE Flange No. ↑ ↓
<b>IPV 3 – 3.5</b>	66	20.5	9	14	38.1	17.5	M8x13	38.1	17.5	M8x13	4.2	10 10
<b>IPV 3 – 5</b>	70	20.5	11	14	38.1	17.5	M8x13	38.1	17.5	M8x13	4.4	10 10
<b>IPV 3 – 6.3</b>	73	20.5	11	19	47.6	22.3	M10x15	38.1	17.5	M8x13	4.6	10 11
<b>IPV 3 – 8</b>	77.5	20.5	13	19	47.6	22.3	M10x15	38.1	17.5	M8x13	4.8	10 11
<b>IPV 3 – 10</b>	82.5	20.5	13	21	52.4	26.2	M10x15	38.1	17.5	M8x13	5.0	10 12

\* Ensure the M10x1 plug screw, hexagon socket SW5, is tightened to a torque of 10 Nm during pumping operation. Dependent on the pump position, filling or ventilation is possible here prior to commissioning.

## IPV Size 3, Designs and dimensions

### Rotation, Suction port

### Mounting flange

### Shaft end

#### Standard

Rotation clockwise,  
Suction port pump

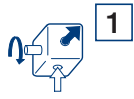

SAE 2-hole flange

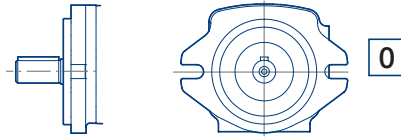

Keyway connection

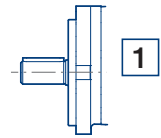

#### Variants

Rotation counterclockwise,  
Suction port pump

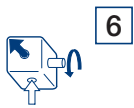

SAE 2-hole flange

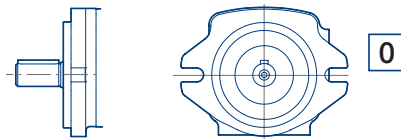

Keyway connection

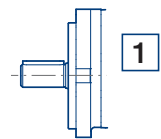

Rotation clockwise\*,  
Suction port pump

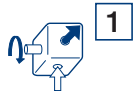

SAE 2-hole flange

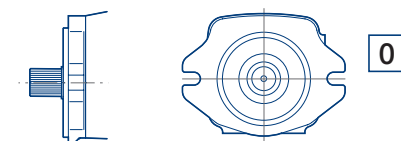

Involute gearing

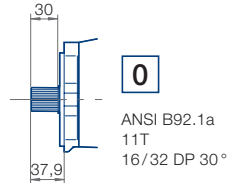

Rotation counterclockwise\*,  
Suction port pump

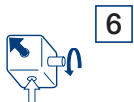

VDMA-2-hole flange

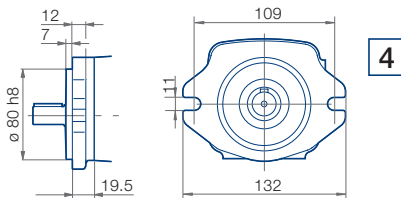

Keyway connection

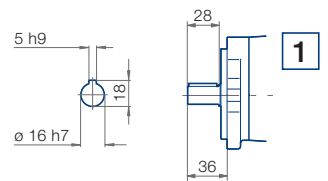

\* Direction of rotation free selectable in the illustrated mounting flange/shaft end combination.

**IPV Size 4, Rotation and dimensions (mounting flange 7, shaft end 1)**

**Rotation clockwise (cw)**

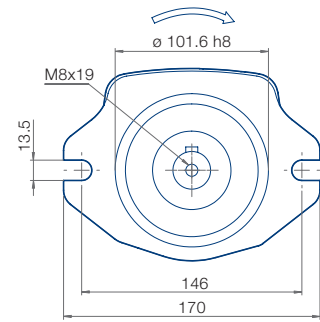
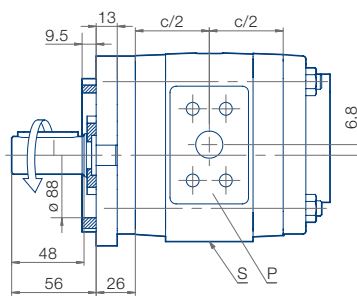
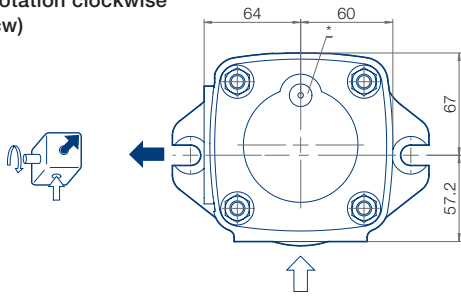

**Rotation counter-clockwise (ccw)**

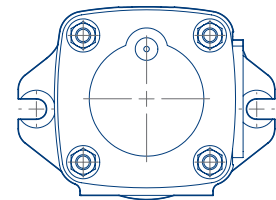
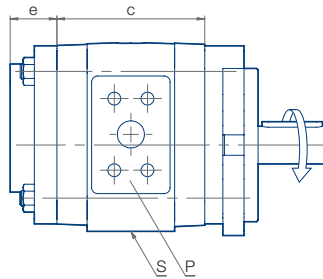
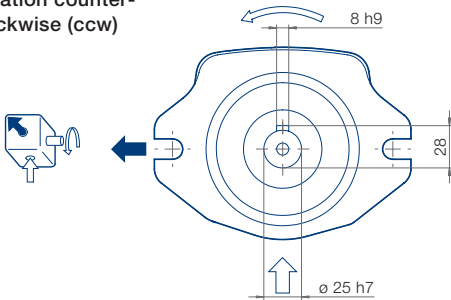

Pressure port (P)

Suction port (S)

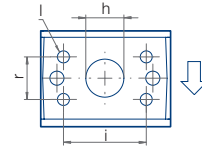
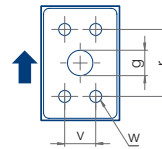

Type/ Delivery	c [mm]	e [mm]	g [mm]	h [mm]	i [mm]	k [mm]	l Thread	r [mm]	v [mm]	w Thread	Weight [kg]	SAE Flange No. ↑ ↓
<b>IPV 4 – 13</b>	88.5	31	13	23	52.4	26.2	M10x15	38.1	17.5	M8x13	9.4	10 12
<b>IPV 4 – 16</b>	92.5	31	14	25	52.4	26.2	M10x15	38.1	17.5	M8x13	9.7	10 12
<b>IPV 4 – 20</b>	98	31	18	27	58.7	30.2	M10x15	47.6	22.3	M10x15	10.2	11 13
<b>IPV 4 – 25</b>	104	31	18	30	58.7	30.2	M10x15	47.6	22.3	M10x15	10.7	11 13
<b>IPV 4 – 32</b>	113	31	18	32	58.7	30.2	M10x15	47.6	22.3	M10x15	11.7	11 13

\* Ensure the M10x1 plug screw, hexagon socket SW5, is tightened to a torque of 10 Nm during pumping operation. Dependent on the pump position, filling or ventilation is possible here prior to commissioning.

## IPV Size 4, Designs and dimensions

### Rotation, Suction port

### Mounting flange

### Shaft end

#### Standard

Rotation clockwise,  
Suction port pump

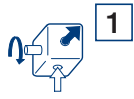

SAE 2-hole flange

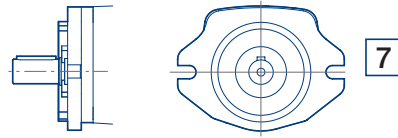

Keyway connection

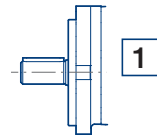

#### Variants

Rotation counterclockwise,  
Suction port pump

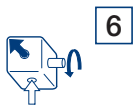

SAE 2-hole flange

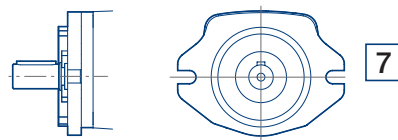

Keyway connection

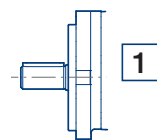

Rotation clockwise\*,  
Suction port pump



SAE 2-hole flange

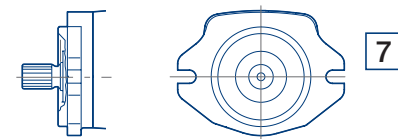

Involute gearing

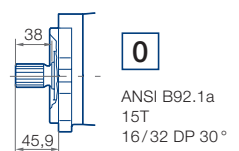

Rotation counterclockwise\*,  
Suction port pump

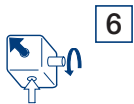

SAE 4-hole flange

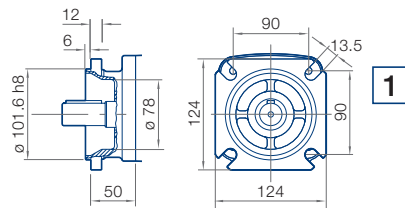

Keyway connection

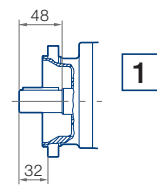

VDMA-4-hole flange

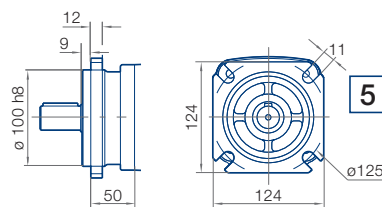

Keyway connection

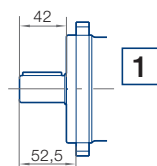

\* Direction of rotation free selectable in the illustrated mounting flange/shaft end combination.

**IPV Size 5, Rotation and dimensions (mounting flange 0, shaft end 1)**

**Rotation clockwise (cw)**

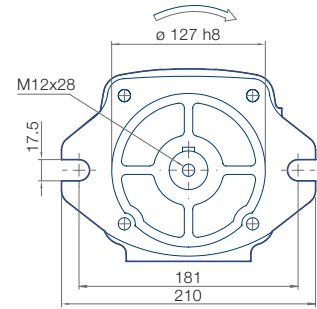
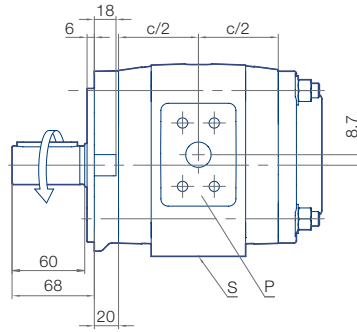
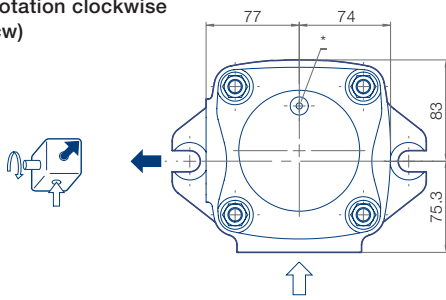

**Rotation counter-clockwise (ccw)**

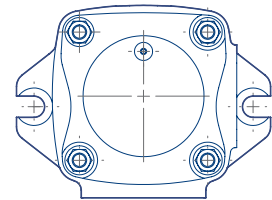
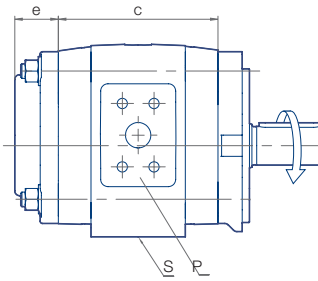
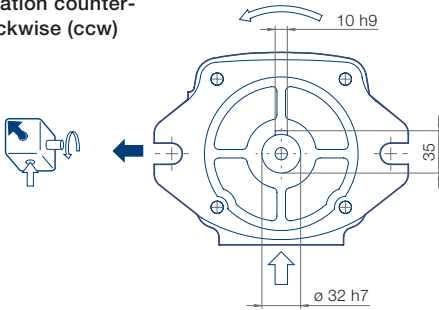

Pressure port (P)

Suction port (S)

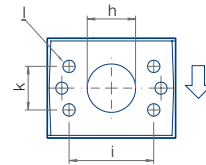
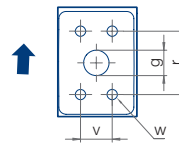

Type/ Delivery	c [mm]	e [mm]	g [mm]	h [mm]	i [mm]	k [mm]	l Thread	r [mm]	v [mm]	w Thread	Weight [kg]	SAE Flange No. ↑ ↓
<b>IPV 5 – 32</b>	119	36	18	32	58.7	30.2	M10x15	47.6	22.3	M10x15	15.6	11 13
<b>IPV 5 – 40</b>	125	36	19	35	69.9	35.7	M12x20	52.4	26.2	M10x15	16.7	12 30
<b>IPV 5 – 50</b>	132	36	21	40	69.9	35.7	M12x20	52.4	26.2	M10x15	17.3	12 30
<b>IPV 5 – 64</b>	143	36	23	40	69.9	35.7	M12x20	52.4	26.2	M10x15	19.1	12 30

\* Ensure the M10x1 plug screw, hexagon socket SW5, is tightened to a torque of 10 Nm during pumping operation.  
Dependent on the pump position, filling or ventilation is possible here prior to commissioning.

Note! In case of oil-immersed installation of the oil pump flange variant 0 can not be used. For this special case, the flange version 7 will be used.



## IPV Size 5, Designs and dimensions

### Rotation, Suction port

### Mounting flange

### Shaft end

#### Standard

Rotation clockwise,  
Suction port pump

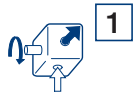

SAE 2-hole flange

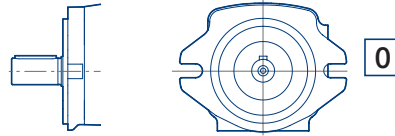

Keyway connection

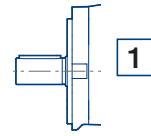

#### Variants

Rotation counterclockwise,  
Suction port pump

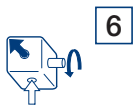

SAE 2-hole flange

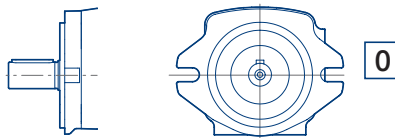

Keyway connection

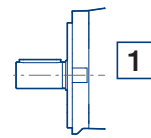

Rotation clockwise\*,  
Suction port pump

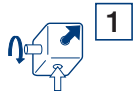

SAE 2-hole flange

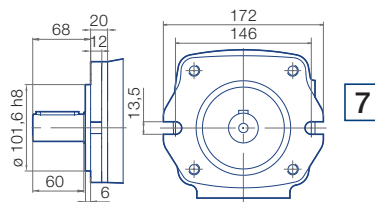

Keyway connection

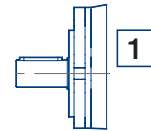

Rotation counterclockwise\*,  
Suction port pump

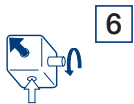

SAE 2-hole flange

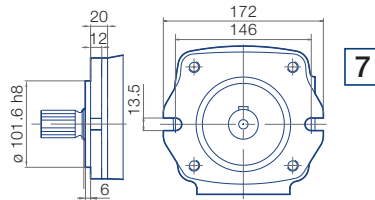

Involute gearing

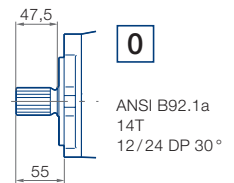

SAE 4-hole flange

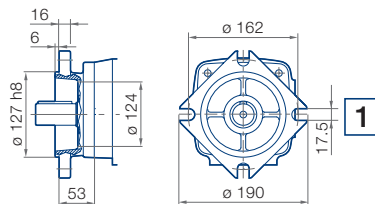

Keyway connection

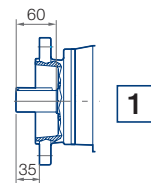

VDMA-4-hole flange

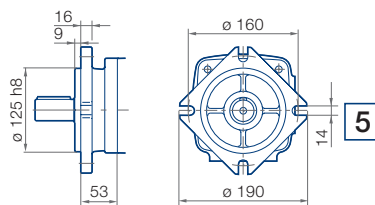

Keyway connection

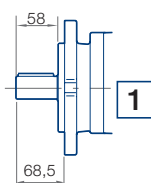

\* Direction of rotation free selectable in the illustrated mounting flange/shaft end combination.

**IPV Size 6, Rotation and dimensions (mounting flange 0, shaft end 1)**

**Rotation clockwise (cw)**

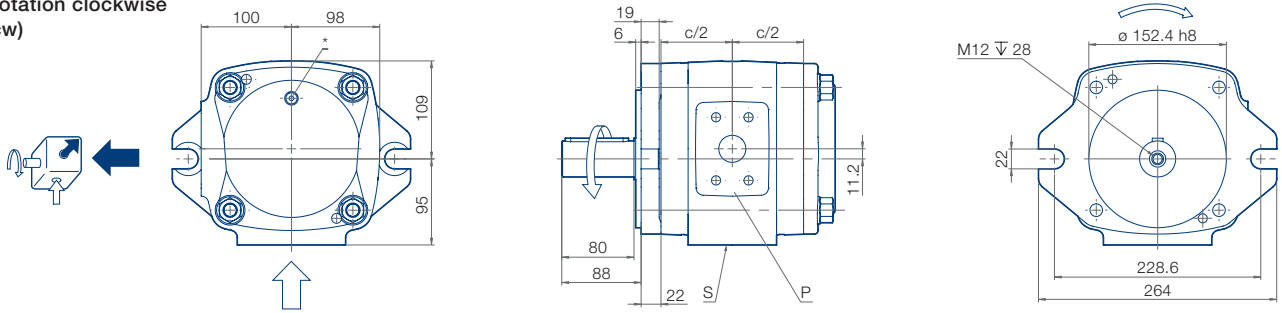

**Rotation counter-clockwise (ccw)**

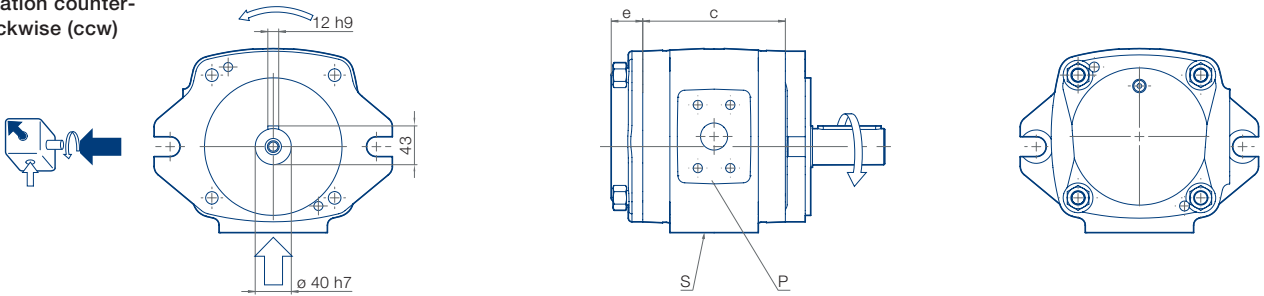

Pressure port (P)

Suction port (S)

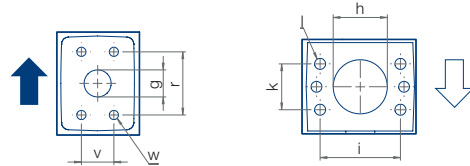

Type/ Delivery	c [mm]	e [mm]	g [mm]	h [mm]	i [mm]	k [mm]	l Thread	r [mm]	v [mm]	w Thread	Weight [kg]	SAE Flange No. ↑	SAE Flange No. ↓
<b>IPV 6 – 64</b>	140	40	23	40	69.9	35.7	M12x20	52.4	26.2	M10x15	30.0	12	30
<b>IPV 6 – 80</b>	148	35	23	45	77.8	42.9	M12x20	69.9	35.7	M12x20	31.7	14	15
<b>IPV 6 – 100</b>	158	35	27	50	77.8	42.9	M12x20	69.9	35.7	M12x20	33.0	14	15
<b>IPV 6 – 125</b>	170	40	30	50	77.8	42.9	M12x20	69.9	35.7	M12x20	36.0	14	15

\* Ensure the M10x1 plug screw, hexagon socket SW5, is tightened to a torque of 10 Nm during pumping operation. Dependent on the pump position, filling or ventilation is possible here prior to commissioning.

**IPV Size 6, Designs and dimensions**

**Rotation, Suction port**

**Mounting flange**

**Shaft end**

**Standard**

Rotation clockwise,  
Suction port pump

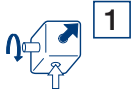

SAE 2-hole flange

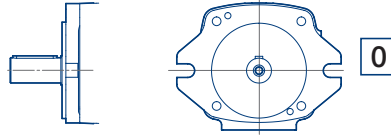

Keyway connection

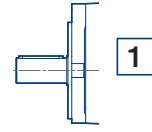

**Variants**

Rotation counterclockwise,  
Suction port pump

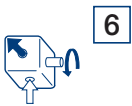

SAE 2-hole flange

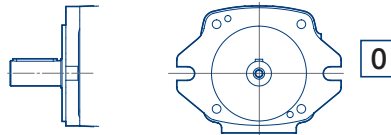

Keyway connection

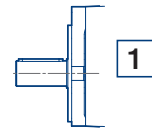

Rotation clockwise\*,  
Suction port pump

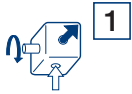

SAE 2-hole flange

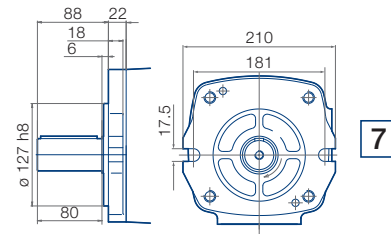

Keyway connection

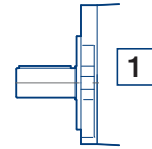

Rotation counterclockwise\*,  
Suction port pump

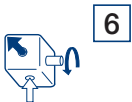

SAE 2-hole flange

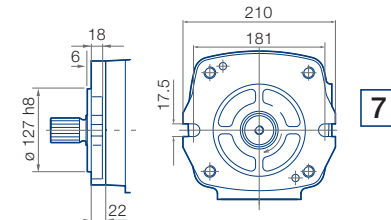

Involute gearing

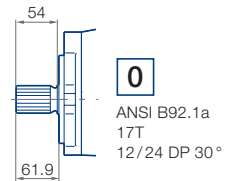

SAE 4-hole flange

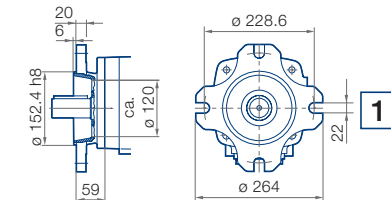

Keyway connection

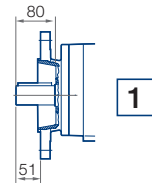

VDMA-4-hole flange

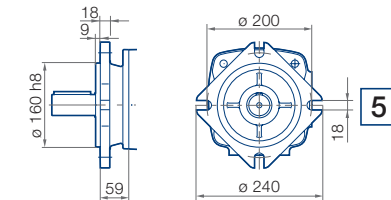

Keyway connection

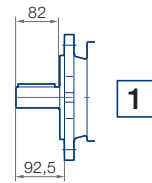

\* Direction of rotation free selectable in the illustrated mounting flange / shaft end combination.

**IPV Size 7, Rotation and dimensions (mounting flange 1, shaft end 1)**

**Rotation clockwise (cw)**

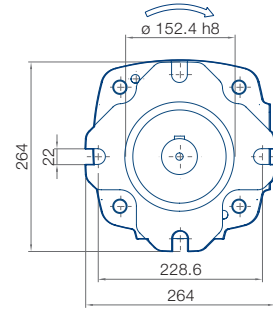
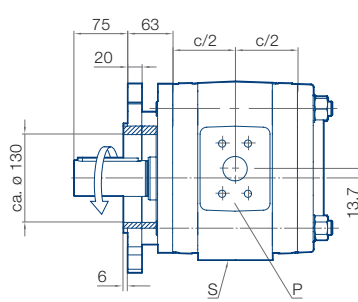
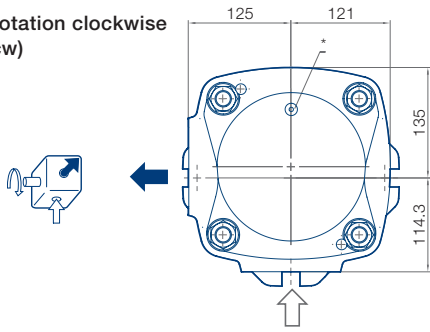

**Rotation counter-clockwise (ccw)**

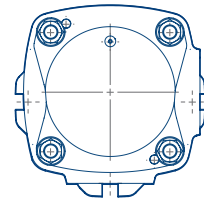
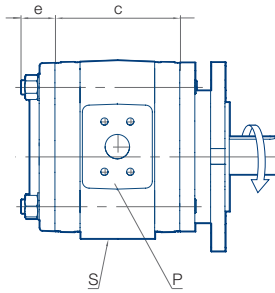
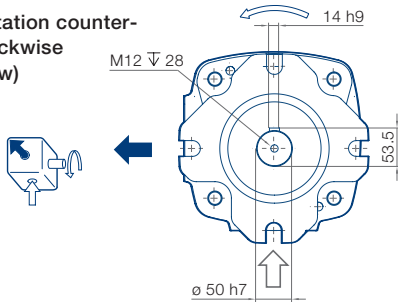

Pressure port (P)

Suction port (S)

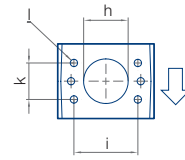
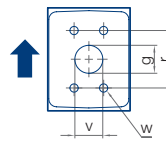

Type/ Delivery	c [mm]	e [mm]	g [mm]	h [mm]	i [mm]	k [mm]	l Thread	r [mm]	v [mm]	w Thread	Weight [kg]	SAE Flange No. ↑ ↓
<b>IPV 7 – 125</b>	152	48	30	50	77.8	42.9	M12x20	69.9	35.7	M12x20	46.5	14 15
<b>IPV 7 – 160</b>	162	48	30	56	88.9	50.8	M12x20	69.9	35.7	M12x20	50.0	14 16
<b>IPV 7 – 200</b>	174	46	34	62	88.9	50.8	M12x20	69.9	35.7	M12x20	54.0	14 16
<b>IPV 7 – 250</b>	188	42	38	72	106.3	61.9	M16x25	69.9	35.7	M12x20	59.0	14 17

\* Ensure the M10x1 plug screw, hexagon socket SW5, is tightened to a torque of 10 Nm during pumping operation. Dependent on the pump position, filling or ventilation is possible here prior to commissioning.

## IPV Size 7, Designs and dimensions

### Rotation, Suction port

### Mounting flange

### Shaft end

#### Standard

Rotation clockwise,  
Suction port pump



SAE 4-hole flange

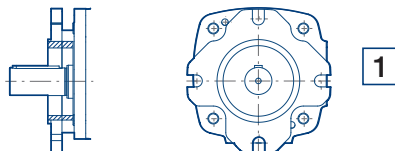

Keyway connection

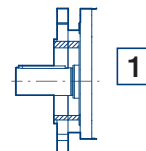

#### Variants

Rotation counterclockwise,  
Suction port pump

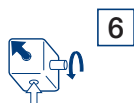

SAE 4-hole flange

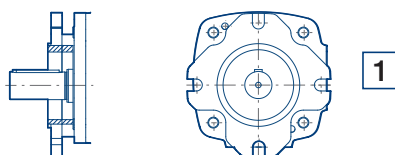

Keyway connection

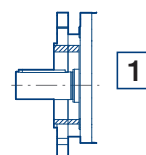

Rotation clockwise\*,  
Suction port pump



SAE 4-hole flange

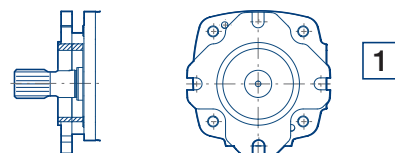

Involute gearing

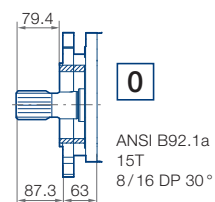

Rotation counterclockwise\*,  
Suction port pump

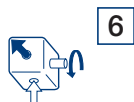

VDMA-4-hole flange

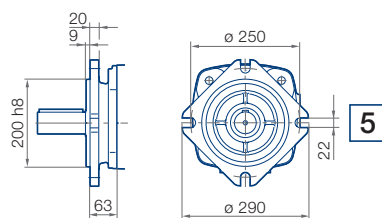

Keyway connection

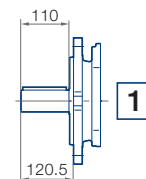

\* Direction of rotation free selectable in the illustrated mounting flange/shaft end combination.

## Measurement values – Airborne noise level (measuring location 1 m axial)

### IPV 3

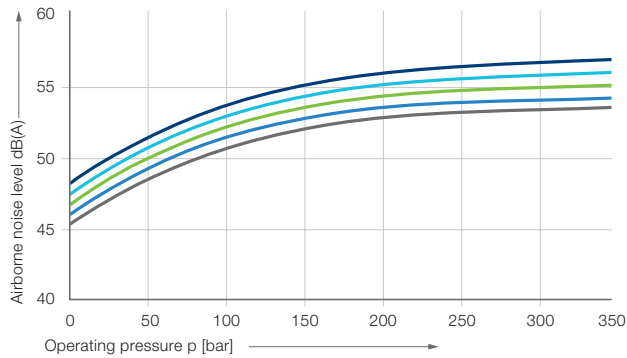

— IPV 3 – 10      — IPV 3 – 8      — IPV 3 – 6.3  
— IPV 3 – 5      — IPV 3 – 3.5

### IPV 4

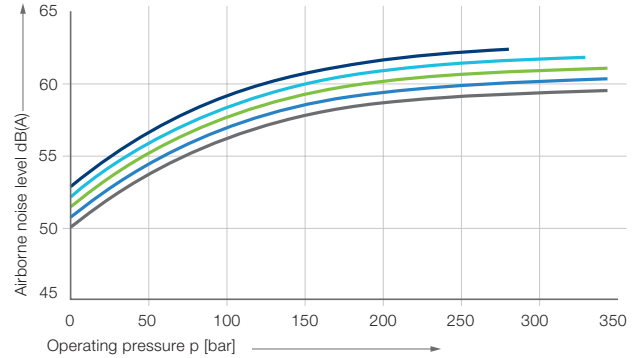

— IPV 4 – 32      — IPV 4 – 25      — IPV 4 – 20  
— IPV 4 – 16      — IPV 4 – 13

### IPV 5

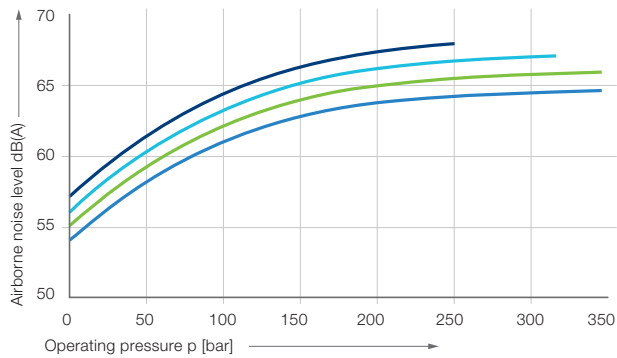

— IPV 5 – 64      — IPV 5 – 50  
— IPV 5 – 40      — IPV 5 – 32

### IPV 6

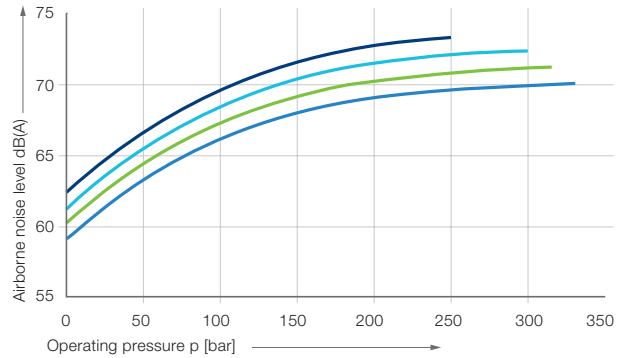

— IPV 6 – 125      — IPV 6 – 100  
— IPV 6 – 80      — IPV 6 – 64

### IPV 7

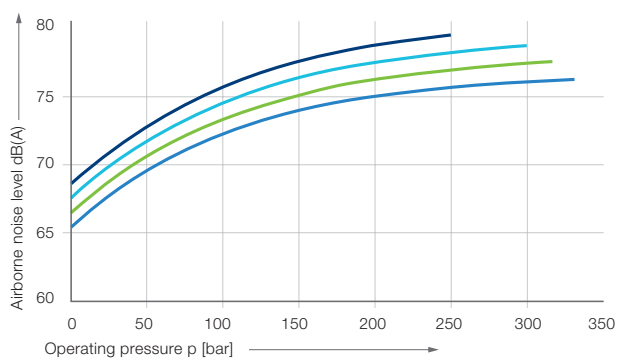

— IPV 7 – 250      — IPV 7 – 200  
— IPV 7 – 160      — IPV 7 – 125

### Measurement conditions

- Speed: 1 500 rpm
- Viscosity of pressure fluid: 46 mm<sup>2</sup>s<sup>-1</sup>
- Operating temperature: 40 °C

### Note

Measurement taken in a low-noise room. In a anechoic room the measurements are approx. 5 dB(A) lower.

## Measurement values – Efficiency $\eta_v$ and $\eta_g$

### IPV 3

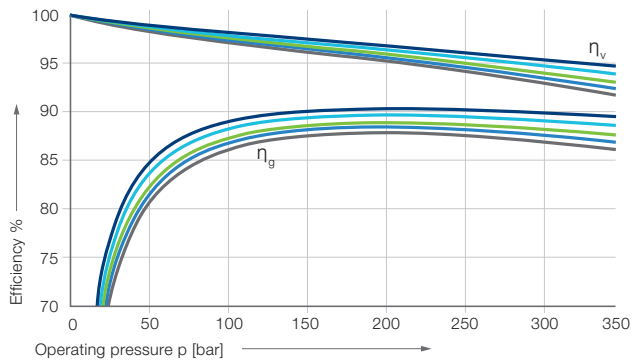

— IPV 3 – 10      — IPV 3 – 8      — IPV 3 – 6.3  
— IPV 3 – 5      — IPV 3 – 3.5

### IPV 4

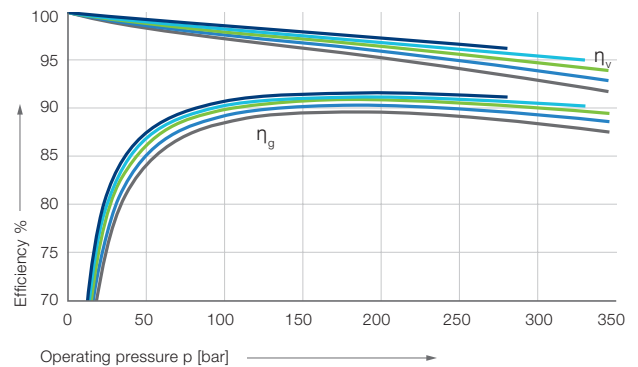

— IPV 4 – 32      — IPV 4 – 25      — IPV 4 – 20  
— IPV 4 – 16      — IPV 4 – 13

### IPV 5

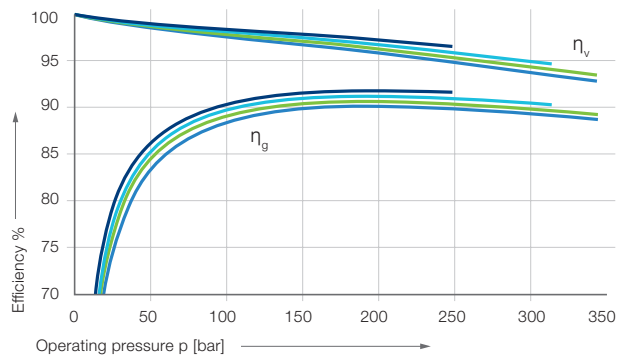

— IPV 5 – 64      — IPV 5 – 50  
— IPV 5 – 40      — IPV 5 – 32

### IPV 6

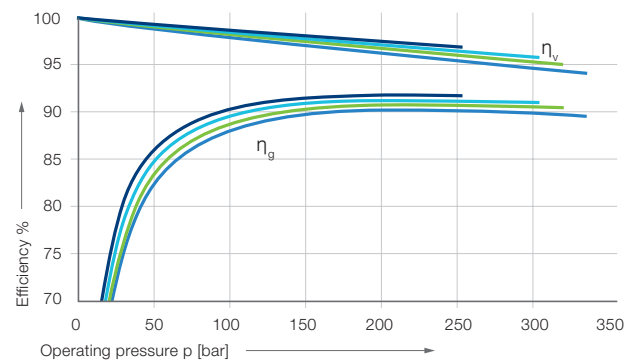

— IPV 6 – 125      — IPV 6 – 100  
— IPV 6 – 80      — IPV 6 – 64

### IPV 7

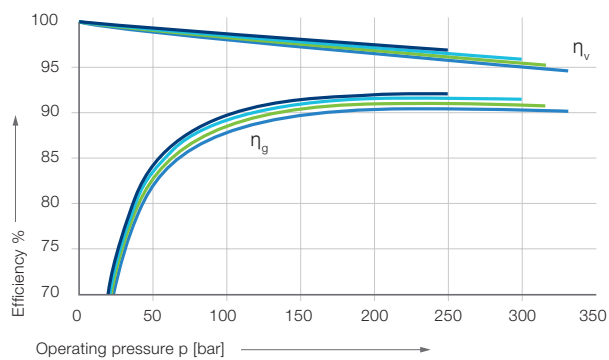

— IPV 7 – 250      — IPV 7 – 200  
— IPV 7 – 160      — IPV 7 – 125

### Measurement conditions

- Speed: 1 500 rpm
- Viscosity of pressure fluid:  $46 \text{ mm}^2\text{s}^{-1}$
- Operating temperature:  $40 \text{ }^\circ\text{C}$

## Suction and pressure flange according to SAE...

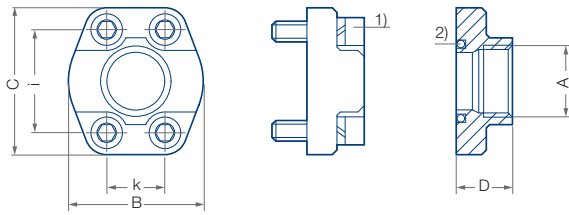

Wrench torque for screws according to ISO 6162

1) Screw EN ISO 4762

2) Round seal ring (O-Ring) ISO-R 1629 NBR

3) Special design. Deviation from SAE J 518 C Code 61

SAE flange no.	A Thread	B [mm]	C [mm]	D [mm]	E <sup>1)</sup> Seal ring	i [mm]	k [mm]	S <sup>2)</sup> Thread	Max. pressure [bar]	
SAE J 518 C Code 61	10	G ½	46	54	36	18.66 – 3.53	38.1	17.5	M8	345
	11	G ¾	50	65	36	24.99 – 3.53	47.6	22.3	M10	345
	12	G 1	55	70	38	32.92 – 3.53	52.4	26.2	M10	345
	13	G 1-¼	68	79	41	37.69 – 3.53	58.7	30.2	M10	276
	14 <sup>3)</sup>	G 1-½	82	98	50	47.22 – 3.53	69.9	35.7	M12	345 <sup>3)</sup>
	30	G 1-½	78	93	45	47.22 – 3.53	69.9	35.7	M12	207
	15	G 2	90	102	45	56.74 – 3.53	77.8	42.9	M12	207
	16	G 2-½	105	114	50	69.44 – 3.53	88.9	50.8	M12	172
	17	G 3	124	134	50	85.32 – 3.53	106.4	61.9	M16	138
	17/2	G 3-½	136	152	48	98.02 – 3.53	120.7	69.9	M16	35
18	G 4	146	162	48	110.72 – 3.53	130.2	77.8	M16	34	
SAE J 518 C Code 62	50	G ½	46	54	36	18.66 – 3.35	40.5	18.2	M8	414
	51	G ¾	55	71	35	24.99 – 3.53	50.8	23.8	M10	414
	52	G 1	65	81	42	32.92 – 3.53	57.2	27.8	M12	414
	53a	G 1-¼	78	95	45	37.69 – 3.53	66.6	31.8	M14	414
	54	G 1-½	94	112	112	47.22 – 3.53	79.3	36.5	M16	414
	55	G 2	114	134	65	56.75 – 3.53	96.8	44.5	M20	400
	56	G 2-½	152	180	80	69.45 – 3.53	123.8	58.8	M24	400



---

## Multi-flow pumps, pump combinations, pump combinations in order of type and size

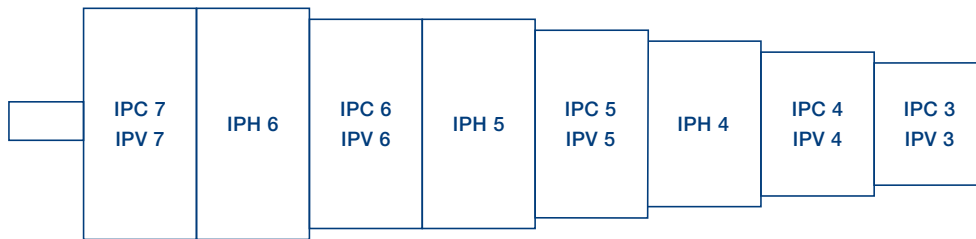

### Combinations of IPV pumps

- IPV pumps of identical or different sizes can be combined in multiflow pumps.
- All sizes of the relevant pump volume are available as two- or three-flow pumps; four-flow pumps must be designed by Voith.
- The pumps are arranged in increasing order according to frame size and delivery.

### Selection

1. Determine pressure ranges and define the appropriate pump serie(s).
2. Determine pump volume and select the appropriate size(s).
3. Define sequence of the pumps.
4. Check the torques.
5. Determine rotation and suction.
6. Specify mounting flange and shaft end.

### Combinations of IPV/IP...-pumps

- It is possible to combine IPV pumps with other Voith.
- The pumps are arranged by types and sizes as shown in the illustration above.
- If identical types or identical sizes follow each other, the pump with the higher pump flow is placed closer to the drive.

### Mounting, assembly

- Multi-flow pumps are generally mounted to the drive by means of a flange. All information about the flange design and shaft end is found in the catalog of the relevant pump series.
- For more information, for example about definition of the adapter housings, refer to brochure G 1714 (Voith multi-flow pump).

## Designs

### Rotation and suction

clockwise (cw)   counterclockwise (ccw)



2

7



1

6



2

7



1

6



3

8

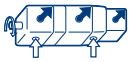

3

8



Special design

4

9

Special design

### Mounting flange



0



1



4

5

7

For designs and dimensions, see catalog of the relevant pump series.

0 SAE-2-hole-flange

1 SAE-4-hole-flange

4 VDMA-2-hole flange

5 VDMA-4-hole flange

7 SAE-2-hole-flange (variant)

### Shaft end



1



0

For designs and dimensions, see catalog of the relevant pump series

## Allowed input torques

Size	A [Nm]	B [Nm]
3	160	80
4	335	190
5	605	400
6	1 050	780
7	1 960	1 200

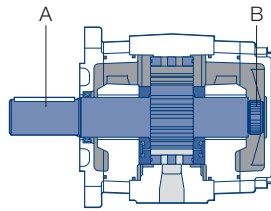

## Type code

IPV 3-3.5 1 0 1

### Shaft end

- 0 Splined gear shaft ANSI B92.1a
- 1 Parallel shaft with keyway

### Mounting flange

- 0 SAE-2-hole
- 1 SAE-4-hole
- 4 VDMA-2-hole
- 5 VDMA-4-hole
- 7 SAE-2-hole, variant

### Rotation, Suction port

- 1 Clockwise rotation, suction port pump
- 6 Anti-clockwise rotation, suction port pump
- 4 Clockwise rotation, special design
- 9 Anti-clockwise rotation, special design

### Delivery

Size	Delivery				
3	3.5	5	6.3	8	10
4	13	16	20	25	32
5	32	40	50	64	
6	64	80	100	125	
7	125	160	200	250	

### Size

### Type

This is a translated document  
Original language: German.  
Legally binding language version of the document: German.

Voith Group  
St. Poeltener Str. 43  
89522 Heidenheim  
Germany

[www.voith.com/hydraulic-systems](http://www.voith.com/hydraulic-systems)

Contact:  
Phone +49 7152 992 3  
[sales-rut@voith.com](mailto:sales-rut@voith.com)



# VOITH

Inspiring Technology  
for Generations